



*User's Guide for  
Climatronics  
WeatherView*

*140 Wilbur Place  
Bohemia, NY 11716  
Phone (631) 567-7300  
Fax (631) 567-7585  
Email: [sales@climatronics.com](mailto:sales@climatronics.com)*



## Table of Contents

<b>1. WEATHERVIEW OVERVIEW.....</b>	<b>1</b>
1.1 SYSTEM OVERVIEW .....	1
1.2 APPLICATION OVERVIEW .....	2
1.3 APPLICATION DATA PROCESSING .....	4
1.3.1 Sensor Update.....	4
1.3.2 Data Averaging and Output Interval .....	4
1.3.2.1 Average Data Processing and Display .....	4
1.3.2.2 Data Storage.....	5
1.3.3 Data FTP Upload .....	6
1.4 APPLICATION VIEWS .....	7
1.4.1 Normal View.....	7
1.4.1.1 Normal View Elements.....	8
1.4.2 Airport View.....	9
1.4.2.1 Airport View Elements .....	10
1.5 APPLICATION MENUS .....	10
1.5.1 File.....	11
1.5.1.1 Exit.....	11
1.5.2 View .....	11
1.5.2.1 Normal Display .....	11
1.5.2.2 Airport Display .....	11
1.5.2.3 Instantaneous Data .....	11
1.5.2.4 Average Data .....	11
1.5.2.5 Current Log File .....	12
1.5.2.6 Archived Log File .....	12
1.5.2.7 Current Input Data .....	13
1.5.2.8 Toolbar.....	13
1.5.2.9 Status Bar.....	14
1.5.3 Setup .....	14
1.5.3.1 System Settings .....	14
1.5.3.2 QNH/QFE Settings .....	16
1.5.3.3 System Configuration .....	17
1.5.3.4 Serial Interface Settings .....	19
1.5.3.5 FTP Settings.....	20
1.5.3.6 TCP/IP Settings .....	21
1.5.3.7 Colors.....	21
1.5.4 Units.....	22
1.5.4.1 Wind Speed – Miles Per Hour.....	23
1.5.4.2 Wind Speed – Meters Per Second.....	23
1.5.4.3 Wind Speed – Knots .....	23
1.5.4.4 Temperature – Fahrenheit .....	23
1.5.4.5 Temperature – Centigrade.....	23
1.5.4.6 Humidity – Relative Humidity.....	23
1.5.4.7 Humidity – Dewpoint.....	23
1.5.4.8 Pressure – Inches Mercury .....	24
1.5.4.9 Pressure – Millibars .....	24
1.5.4.10 Precipitation – Inches.....	24
1.5.4.11 Precipitation – Millimeters.....	24
1.5.4.12 Pressure Display – BP.....	24
1.5.4.13 Pressure Display – BP/QNH .....	24
1.5.4.14 Pressure Display – BP/QFE .....	24
1.5.4.15 Pressure Display – QNH/QFE.....	24
1.5.5 Help .....	25
1.5.5.1 WeatherView Help.....	25
1.5.5.2 About WeatherView .....	25
1.6 REMOTE WORKSTATION - APPLICATION VIEW.....	26
1.7 REMOTE WORKSTATION - APPLICATION MENUS.....	27
1.7.1 Remote Workstation - File .....	27
1.7.1.1 Remote Workstation - Exit.....	27
1.7.2 Remote Workstation - View.....	27
1.7.2.1 Remote Workstation - Normal Display.....	27

---

1.7.2.2	Remote Workstation - Airport Display .....	27
1.7.2.3	Remote Workstation - Instantaneous Data .....	27
1.7.2.4	Remote Workstation - Average Data .....	27
1.7.2.5	Remote Workstation - Toolbar .....	28
1.7.2.6	Remote Workstation - Status Bar .....	28
1.7.3	<i>Remote Workstation - Setup</i> .....	28
1.7.3.1	Remote Workstation - TCP/IP Settings .....	28
1.7.3.2	Remote Workstation - Colors .....	28
1.7.4	<i>Units</i> .....	29
1.7.4.1	Remote Workstation - Wind Speed – Miles Per Hour .....	30
1.7.4.2	Remote Workstation - Wind Speed – Meters Per Second .....	30
1.7.4.3	Remote Workstation - Wind Speed – Knots .....	30
1.7.4.4	Remote Workstation - Temperature – Fahrenheit .....	30
1.7.4.5	Remote Workstation - Temperature – Centigrade .....	30
1.7.4.6	Remote Workstation - Humidity – Relative Humidity .....	30
1.7.4.7	Remote Workstation - Humidity – Dewpoint .....	30
1.7.4.8	Remote Workstation - Pressure – Inches Mercury .....	30
1.7.4.9	Remote Workstation - Pressure – Millibars .....	31
1.7.4.10	Remote Workstation - Precipitation – Inches .....	31
1.7.4.11	Remote Workstation - Precipitation – Millimeters .....	31
1.7.4.12	Remote Workstation - Pressure Display – BP .....	31
1.7.4.13	Remote Workstation - Pressure Display – BP/QNH .....	31
1.7.4.14	Remote Workstation - Pressure Display – BP/QFE .....	31
1.7.4.15	Remote Workstation - Pressure Display – QNH/QFE .....	31
1.7.5	<i>Remote Workstation - Help</i> .....	32
1.7.5.1	Remote Workstation - WeatherView Help .....	32
1.7.5.2	Remote Workstation - About WeatherView ... ..	32

## List of Figures

FIGURE 1.1-1	WEATHERVIEW BLOCK DIAGRAM .....	1
FIGURE 1.2-1	MAIN APPLICATION WINDOW .....	2
FIGURE 1.4-1	NORMAL VIEW, INSTANTANEOUS DATA MODE.....	7
FIGURE 1.4-2	NORMAL VIEW, AVERAGE DATA MODE.....	8
FIGURE 1.4-3	AIRPORT VIEW, INSTANTANEOUS DATA MODE.....	9
FIGURE 1.4-4	AIRPORT VIEW, AVERAGE DATA MODE.....	10
FIGURE 1.5-1	FILE MENU .....	11
FIGURE 1.5-2	VIEW MENU .....	11
FIGURE 1.5-3	CURRENT DATA LOG DISPLAY .....	12
FIGURE 1.5-4	FILE OPEN DIALOG.....	12
FIGURE 1.5-5	ARCHIVED LOG DATA DISPLAY .....	13
FIGURE 1.5-6	LAST RECEIVED INPUT DATA DISPLAY .....	13
FIGURE 1.5-7	SETUP MENU .....	14
FIGURE 1.5-8	SYSTEM SETTINGS DIALOG .....	14
FIGURE 1.5-9	QFE/QNH SETTINGS DIALOG .....	16
FIGURE 1.5-10	SYSTEM CONFIGURATION DIALOG .....	17
FIGURE 1.5-11	INDOOR TEMPERATURE/HUMIDITY USER DEFINED SENSORS EXAMPLE.....	18
FIGURE 1.5-12	SENSOR SERIAL INTERFACE SETTINGS DIALOG.....	19
FIGURE 1.5-13	FTP SETTINGS DIALOG.....	20
FIGURE 1.5-14	TCP/IP SETTINGS DIALOG .....	21
FIGURE 1.5-15	BACKGROUND SELECTION SUBMENU .....	21
FIGURE 1.5-16	COLOR SELECTION MENU .....	22
FIGURE 1.5-17	UNITS MENU .....	22
FIGURE 1.5-18	HELP MENU .....	25
FIGURE 1.5-19	ABOUT WEATHERVIEW DIALOG .....	25
FIGURE 1.6-1	REMOTE WORKSTATION APPLICATION VIEW .....	26
FIGURE 1.7-1	REMOTE WORKSTATION - FILE MENU .....	27
FIGURE 1.7-2	REMOTE WORKSTATION - VIEW MENU .....	27
FIGURE 1.7-3	REMOTE WORKSTATION - SETUP MENU .....	28
FIGURE 1.7-4	REMOTE WORKSTATION - TCP/IP SETTINGS DIALOG .....	28
FIGURE 1.7-5	REMOTE WORKSTATION - BACKGROUND SELECTION SUBMENU.....	28
FIGURE 1.7-6	REMOTE WORKSTATION - COLOR SELECTION MENU .....	29
FIGURE 1.7-7	REMOTE WORKSTATION - UNITS MENU .....	29
FIGURE 1.7-8	REMOTE WORKSTATION - HELP MENU .....	32
FIGURE 1.7-9	REMOTE WORKSTATION - ABOUT WEATHERVIEW REMOTE DIALOG.....	32

## List of Tables

TABLE 1.3-1	PRINTABLE LOG DATA FORMAT .....	5
TABLE 1.3-2	COMMA DELIMITED LOG DATA FORMAT .....	6
TABLE 1.5-1	DISPLAYED DIRECTION VERSUS SENSOR SUPPLIED VALUE AND DIRECTION.....	15

## 1. WeatherView Overview

### 1.1 System Overview

A simplified block diagram of a typical WeatherView installation is shown in Figure 1.1-1. The WeatherView base workstation is a PC computer running Microsoft Win9x/NT/2000/XP with RS-232 and Ethernet LAN interfaces. WeatherView periodically receives raw meteorological data from sensors over the RS-232 serial link. WeatherView processes the raw data and stores it locally. WeatherView also displays the processed meteorological data using one of two graphical representations, a so-called 'normal' display or an 'airport' display. On either display type, the user can select to view either the instantaneous meteorological data values or average values over a user selectable period. Additionally, WeatherView creates a web browser viewable representation of either the normal or airport weather data screens and uploads it periodically via LAN and/or Internet FTP to up to two network servers. It also appends the average data to a rolling data log file that may be reviewed by the user. Remote Stations on the LAN running the WeatherView application in remote station mode access the meteorological data collected by the WeatherView base station via TCP/IP. Remote stations present the same graphical and textual displays as the WeatherView base station. There can be only one WeatherView application running in base station mode, while there can be numerous WeatherView applications running in remote mode.

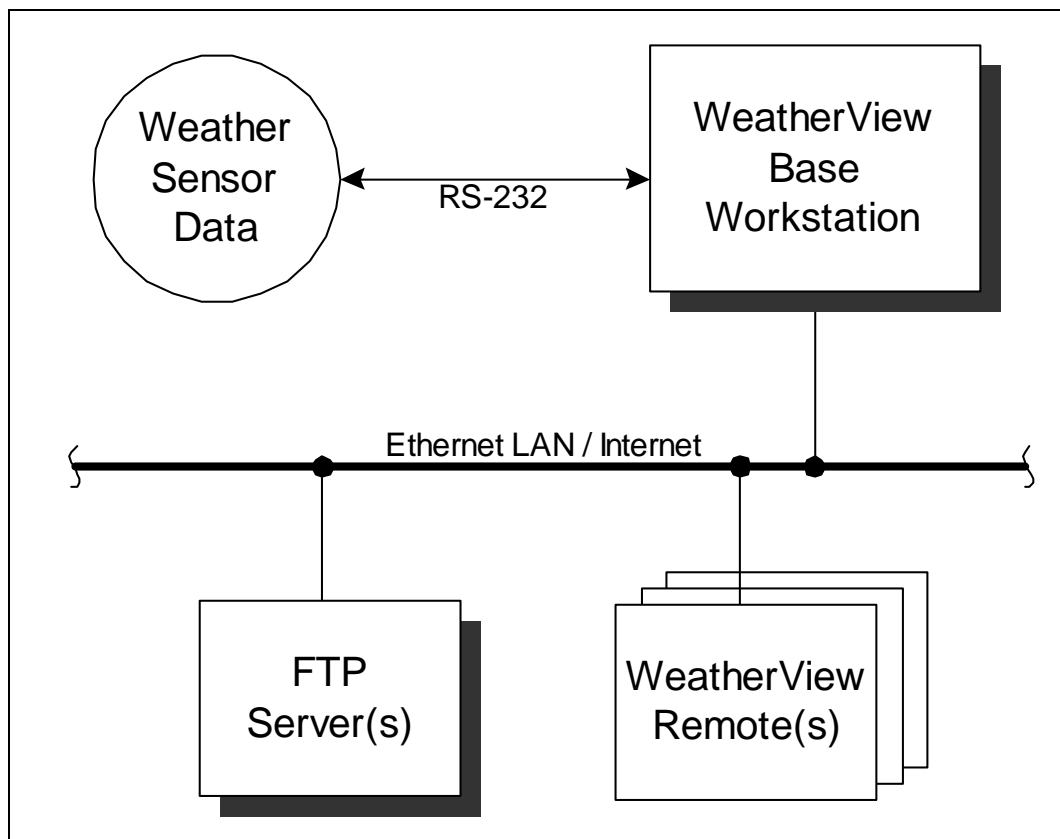
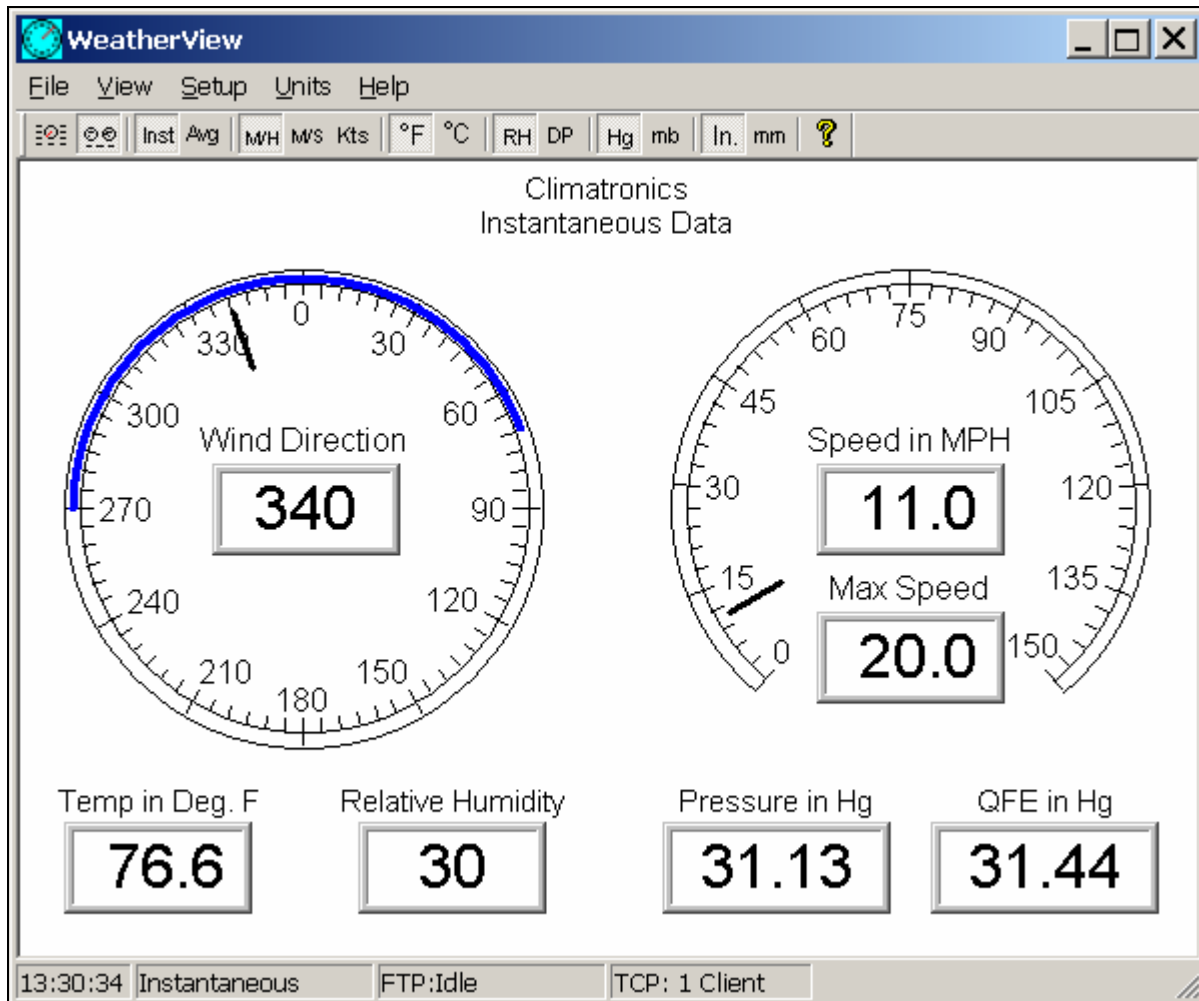

Figure 1.1-1 WeatherView Block Diagram

## 1.2 Application Overview

The main application window for WeatherView (running in base station mode) is shown in Figure 1.2-1. In this example the instantaneous airport view is shown. The application follows standard Windows conventions for layout and control.



**Figure 1.2-1 Main Application Window**

Application functions are accessed primarily through the menu bar. Clicking on a menu item either performs a function or reveals a submenu, from which an item may be selected.

The toolbar presents fast access to some of the frequently used menu functions. Clicking on a toolbar button performs the same function as the associated menu item.

At the bottom of the display is the status bar. The status bar contains four status panes. The contents of the four panes are:

- Time – current PC time.
- Type of data currently displayed (either instantaneous or average).
- FTP upload status (Base station mode only) –
  1. FTP: Idle: no current FTP activity.
  2. FTP: Initialize: FTP process is initializing the connection to the server.
  3. FTP: Login: FTP process is attempting to login to the server.
  4. FTP: Upload: FTP process is uploading to the FTP server.
  5. FTP: Error ##: FTP process experienced an error. If error persists, report error identifier to system administrator.
- TCP/IP status (Base station mode) –
  1. TCP: Listening: WeatherView base station server awaiting connection to a WeatherView remote.
  2. TCP: # Client(s): WeatherView base station server connected to ‘#’ clients.
  3. TCP: Sock Err: WeatherView application unable to create a server TCP/IP socket. Restart application. If error persists, report error to system administrator.
  4. TCP: Listen Err: WeatherView base station server not able to set TCP/IP socket to ‘listen’ for incoming connection requests. Restart application. If error persists, report error to system administrator.
- TCP/IP status (Remote station mode) –
  1. TCP: Connected: WeatherView remote connected to WeatherView base station.
  2. TCP: No Connect: WeatherView remote no longer connected to WeatherView base station.
  3. TCP: SockErr: WeatherView application unable to create a client TCP/IP socket. Restart application. If error persists, report error to system administrator.
  4. TCP: No Server: WeatherView remote not able to connect to the base station IP specified in the TCP/IP Settings Dialog (see Section 1.7.3.1). Confirm base station IP address with system administrator.

## **1.3 Application Data Processing**

Processing in the WeatherView base station is driven by three periodic, but independent, data update rates- the sensor update data rate, the averaging and output data rate and the FTP upload data rate (when 'instantaneous' FTP mode is selected by the user). The processing and activities that occur during these three intervals are described below.

### **1.3.1 Sensor Update**

The sensor update rate is defined by the particular application, and set by the user using the System Settings dialog (see Section 1.5.3.1). When data is received on the serial interface, the data is stored internally and if an instantaneous data view is currently active, all instantaneous values are refreshed with the new current values. Additionally, if the Current Input Data screen is being viewed (see Section 1.5.2.7) or if the System Configuration dialog is displayed (see Section 1.5.3.3), the current input data stream (and the individual sensor components in the case of the system configuration dialog) is refreshed to the latest values received. Finally, the instantaneous data is sent to any and all WeatherView remote workstations connected to the base station.

### **1.3.2 Data Averaging and Output Interval**

The data averaging and output interval is set by the user using the System Settings dialog (see Section 1.5.3.1). Two basic operations are performed periodically at the data averaging and output interval:

1. Computation and display of average data
2. Addition of the average data to the current log file
3. Transmission of the average data to the remote workstations (block average mode only)

The data averaging and output operations only start after at least a full interval (as set by the user) has passed since the start of the WeatherView application. Additionally, the data averaging and output operations take place on even minute boundaries of the system clock. For example, if the averaging interval is set to two minutes and the application is started at 8:01:32, the data averaging and output will take place at 8:04:00, 8:06:00, 8:08:00 and so on. The data averaging and output functions are described below.

#### **1.3.2.1 Average Data Processing and Display**

All sensor readings obtained during an averaging interval are stored internally. At each averaging cycle, an average is computed for all of the individual sensor readings based upon the type of averaging specified by the user via the System Settings dialog (see Section 1.5.3.1). If a rolling average is selected, the average data represents the average of the values over the last average interval (as specified with the Average Interval radio boxes). If block average is selected on the other hand, the display will only update at the average interval selected and the average data shown represents the average over the prior average interval. Additionally, the maximum wind speed reading obtained during the last average interval and the wind direction extents are determined at each averaging cycle. The individual sensor average values are updated if either the normal or airport average view is currently displayed, while the maximum wind speed and wind direction variability is always updated on all four variations of the display.

### 1.3.2.2 Data Storage

After the average values are computed, the average data is appended to the current month's log file. A new log file is started every month at 12:00am of the first calendar day and is given a name using the format `yyyymm.dat`, where 'yyyy' is the year and 'mm' is the month. The monthly logs remain on the system unless deleted by the user. The data is written to the log in one of two user-selectable log formats. Selecting Printable (see 1.5.3.1) causes the data record to be written in an easy to read printable format as shown in the example:

```
01+0001. 02+2006. 03+0102. 04+0940. 05+012.3 ..... 14+061.1 15+081.1
```

Each element has a unique numerical identifier and format as described in Table 1.3-1.

**Table 1.3-1 Printable Log Data Format**

Element ID	Data Element	Format
01	Current averaging interval in minutes	####.
02	Year	####.
03	Day of the year (i.e. 1 – 366)	####.
04	Hour and minute (24 hour format, hhmm)	####.
05	Wind speed	###.#
06	Wind direction	####.
07	Wind direction standard deviation	###.#
08	Temperature	###.#
09	Humidity	###.#
10	Pressure (if displayed) – Inches of Mercury: Millibars:	##.## ####.##
11	QNH (if displayed) – Inches of Mercury: Millibars:	##.## ####.##
12	QFE (if displayed) – Inches of Mercury: Millibars:	##.## ####.##
13	Radiation	####.
14	Precipitation / Soil Temp. / Wet Bulb Temp. / Indoor Temp. / Indoor Relative Humidity	#.### ###.#
15	Battery Voltage / Soil Temp. / Wet Bulb Temp. / Indoor Temp. / Indoor Relative Humidity	##.## ###.#

Selecting 'CSV' (Comma Separated – Variable, see Section 1.5.3.1) causes the data record to be written in a format that can be more easily parsed by popular spreadsheet programs as shown in the example:

```
1,2006,102,0941,12.5,355,43.1,77.9,28,31.32,31.63,869,59.0,79.0
```

The order of the elements and format is described in Table 1.3-2.

**Table 1.3-2 Comma Delimited Log Data Format**

<b>Element No.</b>	<b>Data</b>	<b>Format</b>
1	Averaging Interval (min)	##
2	Year	####
2	Day of the year (i.e. 1 – 366)	###
3	Hour and minute (24 hour format, hhmm)	####
5	Wind speed	###.#
6	Wind direction	###
7	Wind direction standard deviation	###.#
8	Temperature	###.#
9	Humidity	###
10	Pressure (if displayed) – Inches of Mercury: Millibars:	##.## ####.##
11	QNH (if displayed) – Inches of Mercury: Millibars:	##.## ####.##
12	QFE (if displayed) – Inches of Mercury: Millibars:	##.## ####.##
13	Radiation (if available)	###
14	Precipitation / Soil Temp. / Wet Bulb Temp. / Indoor Temp. / Indoor Relative Humidity	#.### ###.#
15	Battery Voltage / Soil Temp. / Wet Bulb Temp. / Indoor Temp. / Indoor Relative Humidity	##.## ###.#

The user may view the current log data by selecting View-Current Log (see Section 1.5.2.5) or view a previous months log by selecting View- Archived Log File (see Section 1.5.2.6). Note that in both the Printable and Comma Delimited logs, the data that is written to the log reflects the current units of measure selected by the user via the System Setting dialog (see Section 1.5.3.1). Note also that the currently displayed pressure element(s) (i.e. BP, BP and QNH, BP and QFE or QNH and QFE) determines what pressure element(s) are written to the log.

### 1.3.3 Data FTP Upload

If activated by the user, a web browser viewable representation of either the normal or airport data view is uploaded to up to two FTP servers. The access characteristics of the FTP, as well as the data mode (i.e. instantaneous or average) and view mode (i.e. normal or airport) are defined by the user via the FTP Settings dialog (see Section 1.5.3.5). If the user selects the 'instantaneous' data mode, the data view is FTP'ed to the server every five seconds. If the user selects the 'average' data mode, the data is FTP'ed at the conclusion of the Average Data Processing and Display cycle. The status of the upload appears in the main application status bar (e.g. "FTP: Login"). If the FTP operation fails, a suitable error message is shown in the status bar, and remains there until the next cycle.

## 1.4 Application Views

Two basic views are available in the application client area – the normal view or the airport view. Selecting either view is performed using the view menu or using the associated toolbar button. Following standard Windows conventions, the application may be maximized, minimized, or resized using the sizing border. Each view can be set to show either the current instantaneous data or the average values of the data over a user specified interval.

### 1.4.1 Normal View

The normal view is selected using the View pulldown menu or by clicking on the normal view icon on the toolbar. The normal view consists of up to ten digital display areas and an analog wind direction meter. A sample instantaneous normal view is shown in Figure 1.4-1.

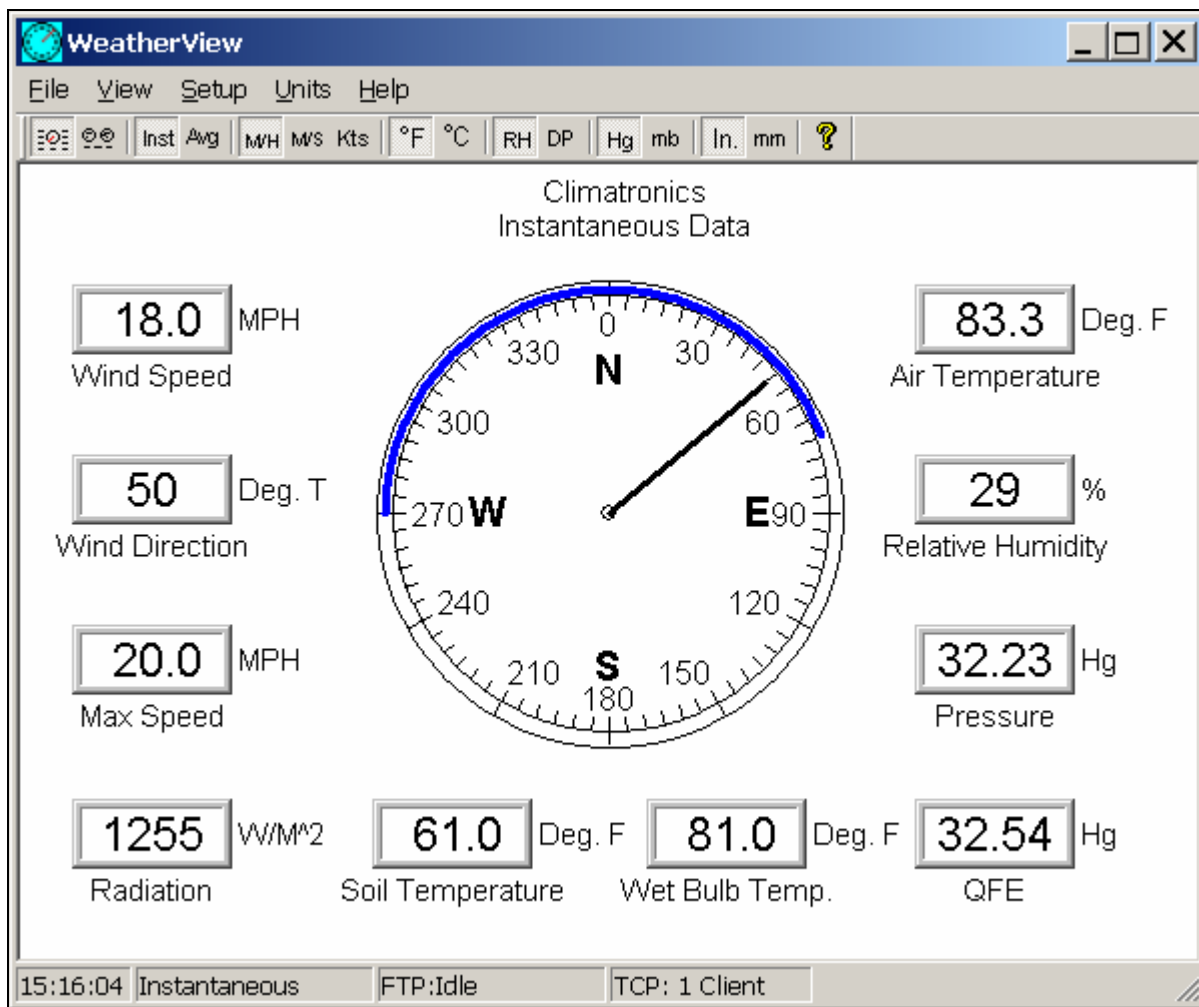

**Figure 1.4-1 Normal View, Instantaneous Data Mode**

The average normal view, which can be selected from the View pulldown or by clicking the appropriate icon on the toolbar, is very similar to the instantaneous normal display and is shown in Figure 1.4-2.

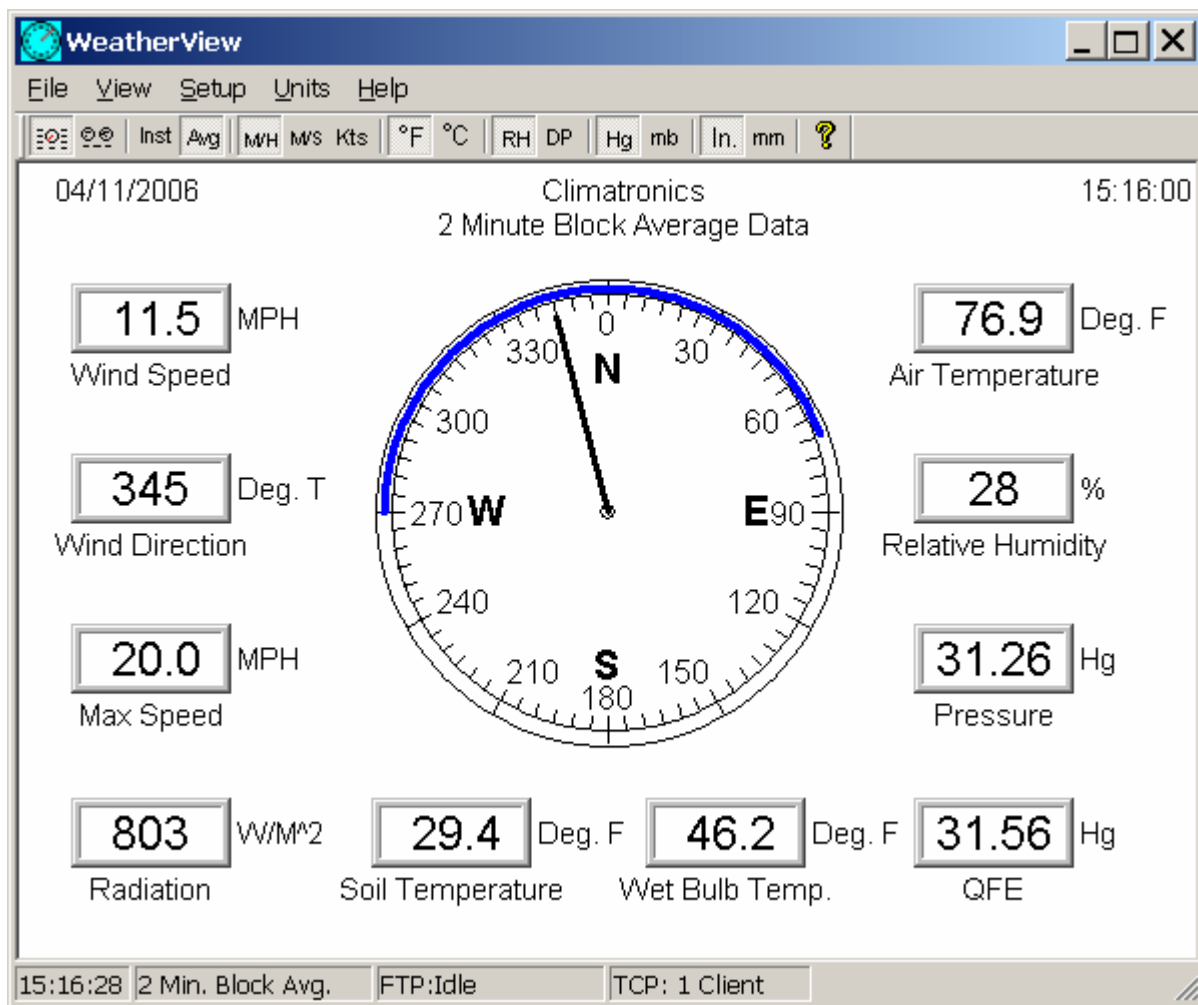

**Figure 1.4-2 Normal View, Average Data Mode**

### 1.4.1.1 Normal View Elements

In both the instantaneous and average normal views, digital display areas are provided for the wind speed, wind direction, maximum wind speed, radiation, air temperature, relative humidity, pressure/pressure and QNH/pressure and QFE/QNH and QFE, precipitation/soil temp./wet bulb temp./indoor temp./indoor relative humidity and battery voltage/soil temp./wet bulb temp./indoor temp./indoor relative humidity, depending on the sensors and pressure display type selected. The units of measure associated with each of these digital display areas can be varied using the Units pulldown menu or with the units icons on the toolbar. Note that the maximum speed display is unique in that there cannot be an instantaneous maximum wind speed. The maximum speed can only be calculated over the interval of interest. On the instantaneous display therefore, the maximum speed indicator shows the maximum speed over the last average interval, not any instantaneous value. As such, the maximum speed indicator on the instantaneous display will show asterisks until the first average interval has passed and a maximum value can be computed.

The normal view also includes an easy to read analog display of the wind direction. The blue band on the analog dial indicates the variability of the wind direction over the last interval of interest. Like the maximum wind speed, the blue band will appear on the instantaneous display only after the average interval has passed and the wind variability can be calculated.

## 1.4.2 Airport View

The airport view is selected using the View pulldown menu or by clicking on the airport view icon on the toolbar. The airport view consists of up to seven digital display areas and two analog meters, one indicating wind direction and the other indicating wind speed. The instantaneous version of the airport view is shown in Figure 1.4-3.

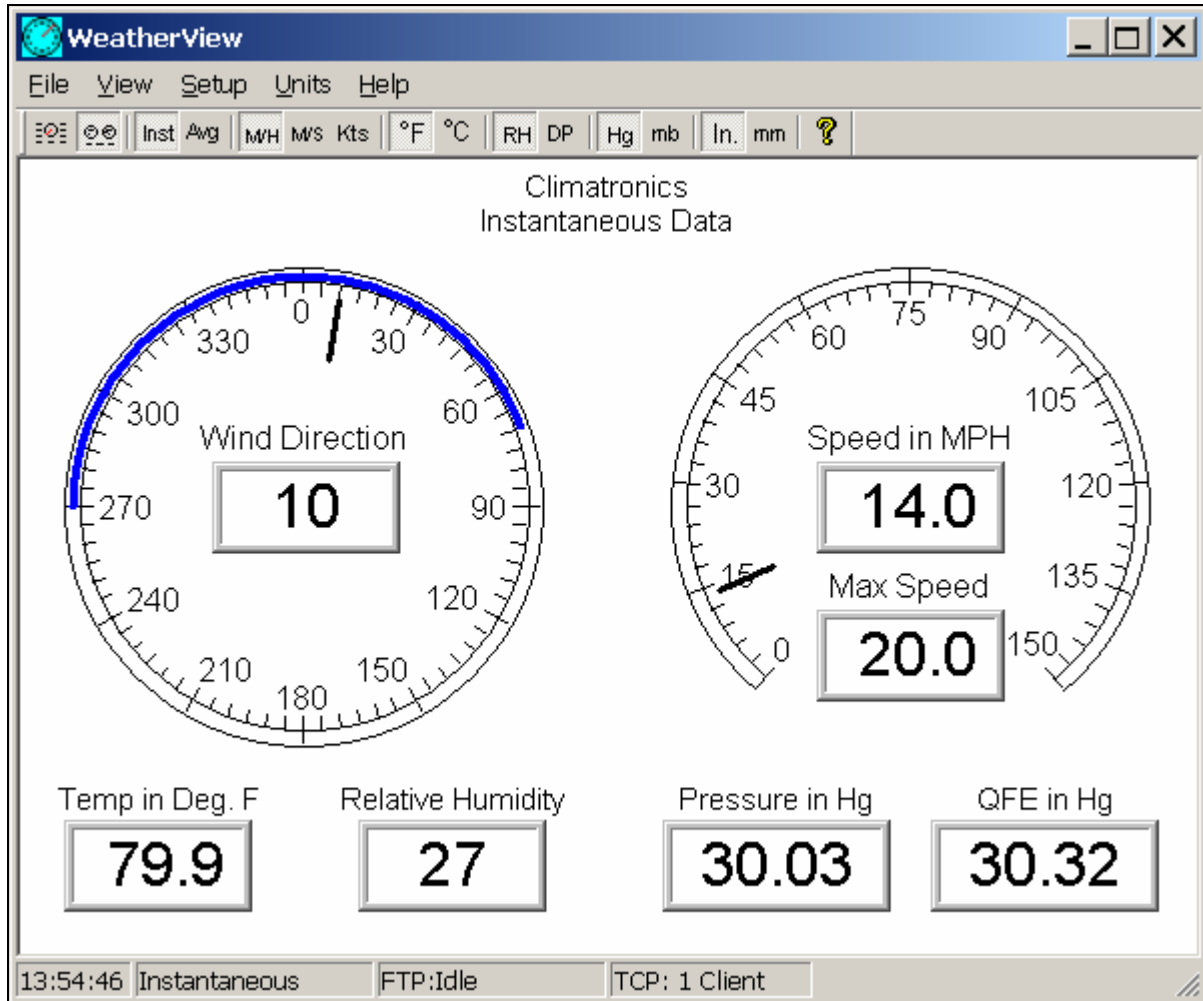

**Figure 1.4-3 Airport View, Instantaneous Data Mode**

The average airport view, which can be selected from the View pulldown or by clicking the appropriate icon on the toolbar, is very similar to the instantaneous airport display and is shown in Figure 1.4-4.

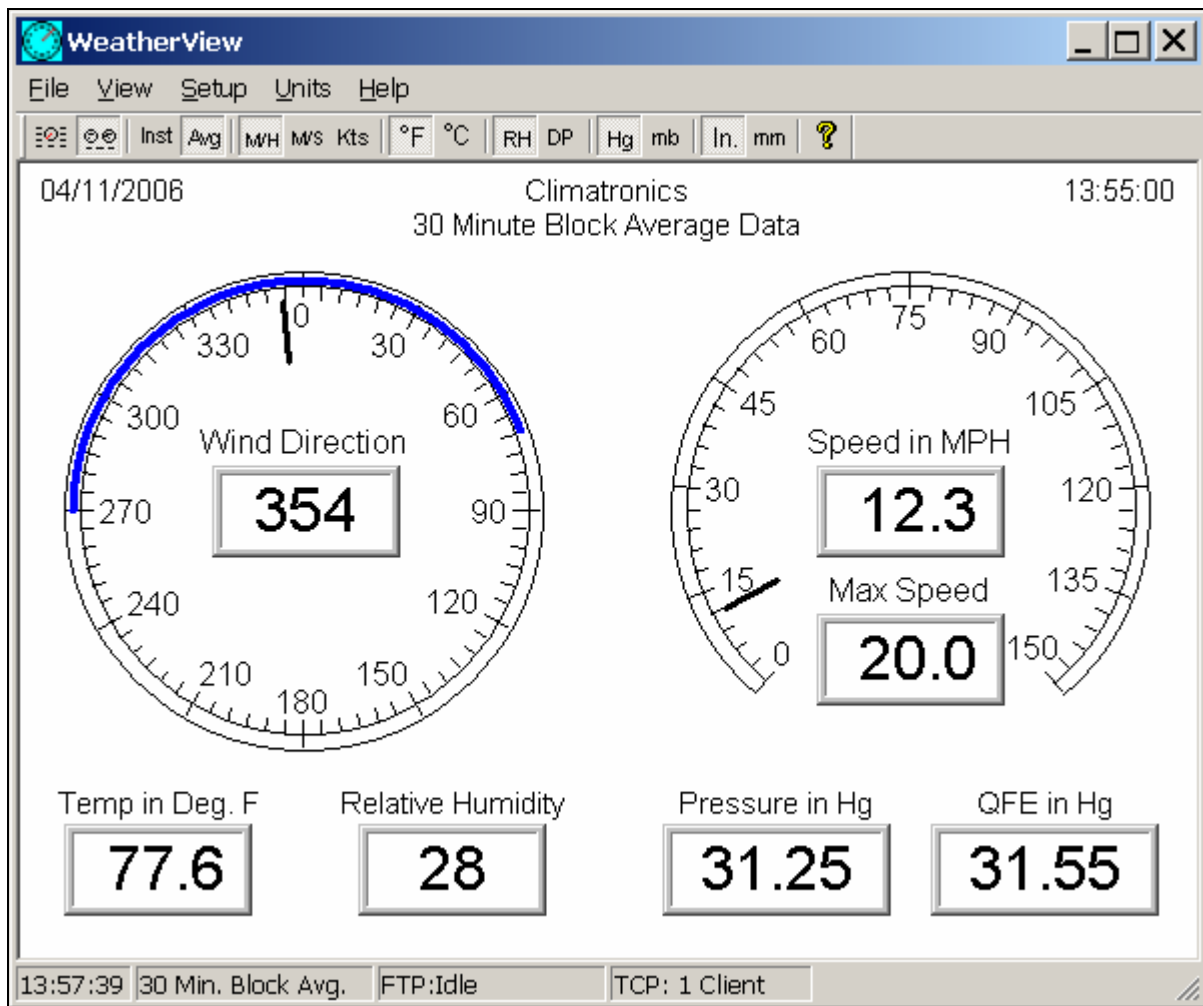

**Figure 1.4-4 Airport View, Average Data Mode**

### 1.4.2.1 Airport View Elements

In both the instantaneous and average airport views, digital display areas are provided for the wind direction, wind speed, maximum wind speed, air temperature, relative humidity, and pressure/pressure and QNH/pressure and QFE/QNH and QFE, depending on the sensors and pressure display type selected. The units of measure associated with each of these digital display areas can be varied using the Units pulldown menu or with the units icons on the toolbar.

The airport view also includes two easy to read analog displays of the wind direction and speed. The blue band on the wind direction analog dial indicates the variability of the wind direction over the last interval of interest.

## 1.5 Application Menus

Much of the operation of the WeatherView application is accomplished through the application menu. Selecting a menu item causes a submenu to be presented. Selecting a submenu item in turn causes an action to be performed, an interface element such as a dialog box to be displayed, or another submenu to be displayed. Menu items may be associated with a toolbar icon, and/or a keyboard “hot key” combination. The following sections describe the functions performed by each menu and submenu item.

## 1.5.1 File



Figure 1.5-1 File Menu

### 1.5.1.1 Exit

Toolbar: No

Exits the application.

## 1.5.2 View

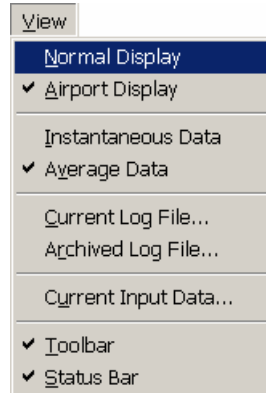

Figure 1.5-2 View Menu

### 1.5.2.1 Normal Display

Toolbar: 

The normal display view is opened. Refer to Section 1.4.1 for a complete description of this view.

### 1.5.2.2 Airport Display

Toolbar: 

The airport display view is opened. Refer to section 1.4.2 for a complete description of this view.

### 1.5.2.3 Instantaneous Data

Toolbar: 

The current data view (either airport or normal) is modified to show the instantaneous data values being received from the weather sensors.

### 1.5.2.4 Average Data

Toolbar: 

The current data view (either airport or normal) is modified to show the average data values over the specified average interval.

### 1.5.2.5 Current Log File ...

Toolbar: No

The Current Data Log file display is opened. The data log display allows the user to review the data stored in the current months log file. This file contains all data collected in the last month up to the time of display. A sample Current Data Log data log display is shown in Figure 1.5-3. The format of the data displayed is discussed in Section 1.3.2.2.

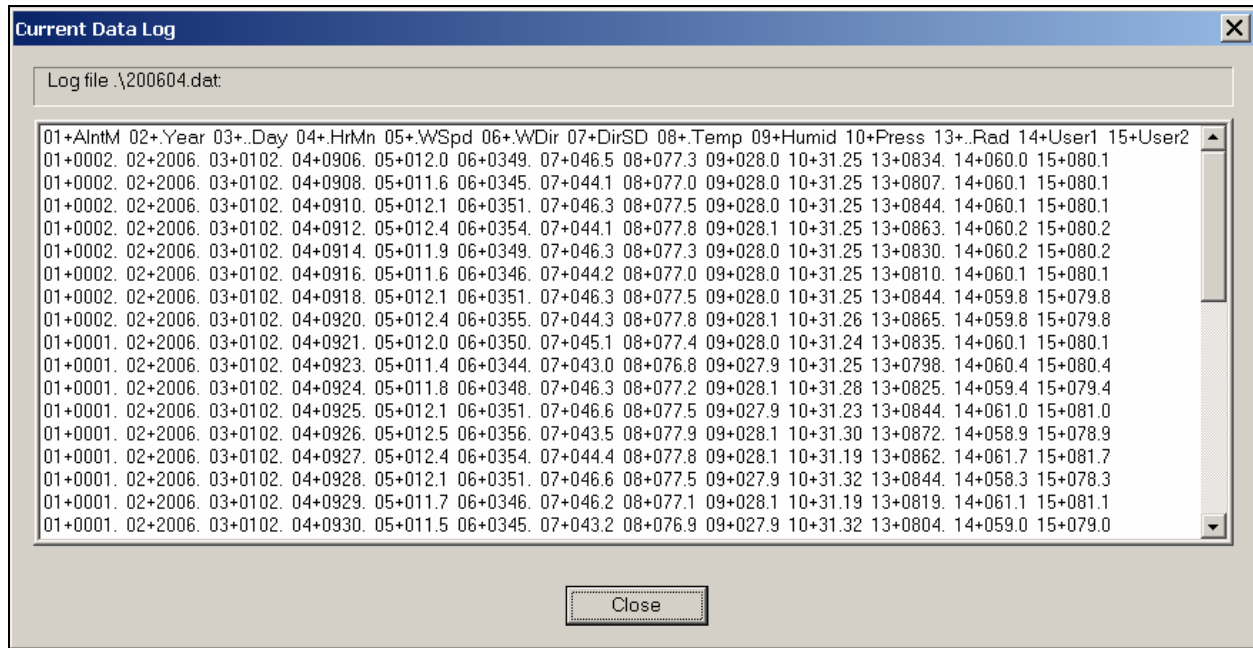

Figure 1.5-3 Current Data Log Display

### 1.5.2.6 Archived Log File ...

Toolbar: No

The Archived Log File selection allows the user to view an archived log file from a previous month. Selecting View Archived Log File causes a standard Windows Open File dialog to be displayed as shown in Figure 1.5-4.

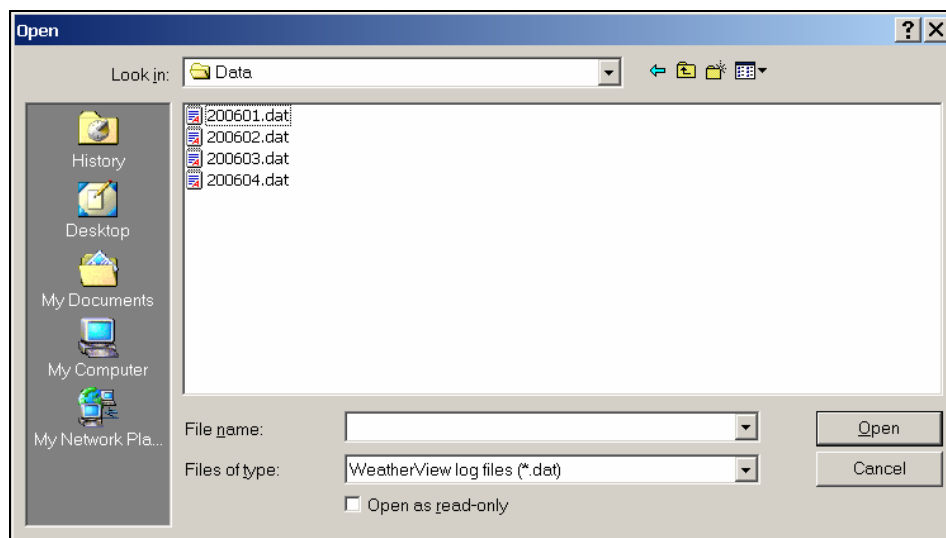
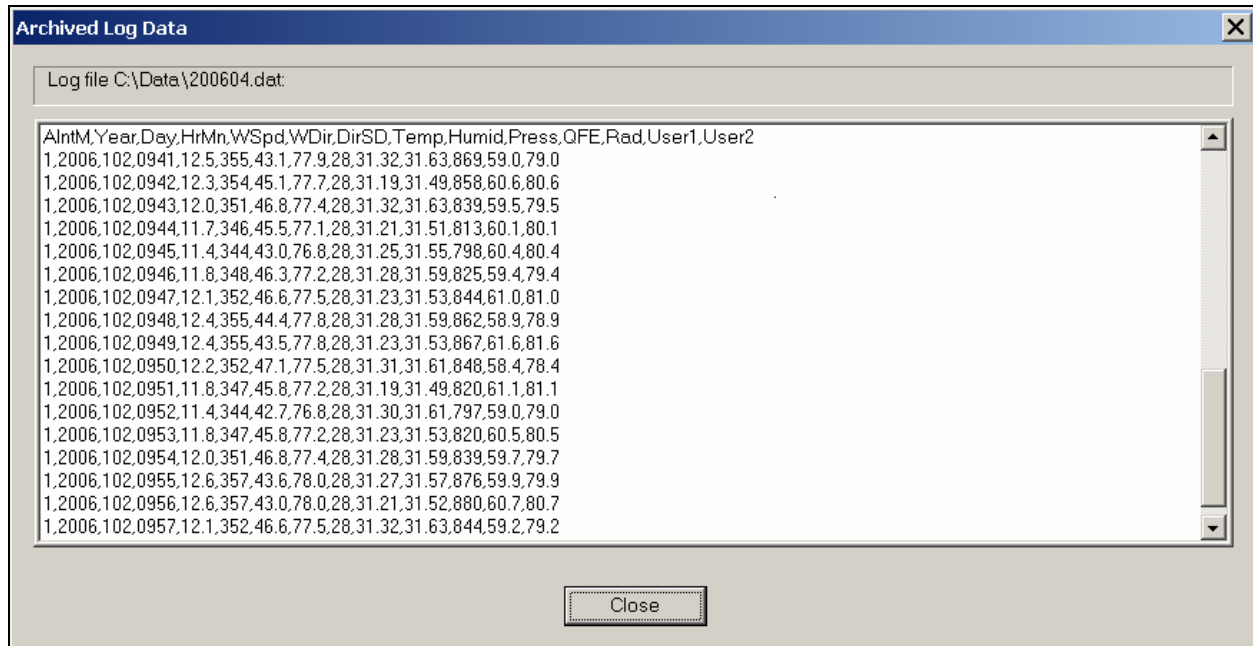

Figure 1.5-4 File Open Dialog

The user can browse for files using the 'Look In:' pulldown menu and the 'higher level' icon, and can select the file of choice by typing the filename in the appropriate box or by clicking on the file in the view window. Selecting Open (or double clicking a filename in the view area) causes the Archived Data Log view to be displayed showing the data in the selected file. The Archived Data Log display is identical to the Current log file Display. A sample archived data log view is shown in Figure 1.5-5.

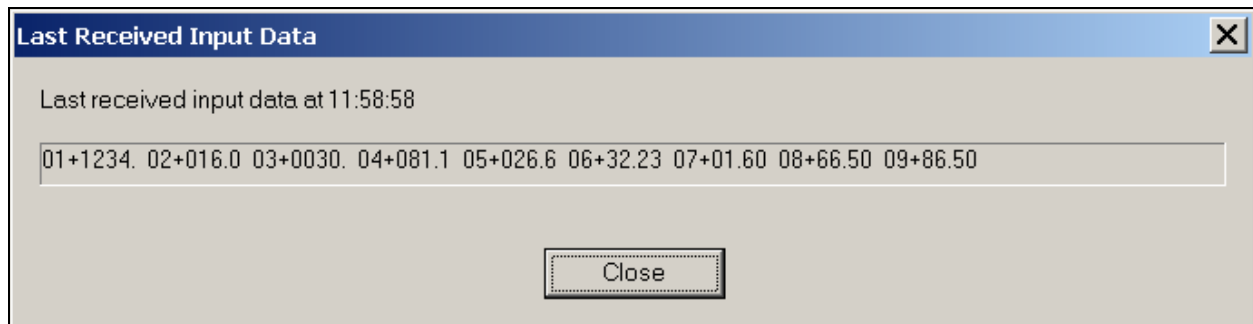

**Figure 1.5-5 Archived Log Data Display**

### 1.5.2.7 Current Input Data ...

Toolbar: No

The Current Input Data selection allows the user to view in real time the raw, unprocessed, meteorological sensor data received over the serial link. A sample Last Received Input Data screen is shown in Figure 1.5-6.



**Figure 1.5-6 Last Received Input Data Display**

### 1.5.2.8 Toolbar

Toolbar: No

The display of the main application toolbar is toggled on or off.

### 1.5.2.9 Status Bar

Toolbar: No

The display of the main application status bar is toggled on or off.

### 1.5.3 Setup

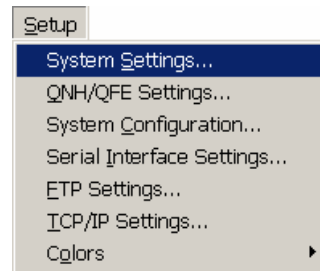
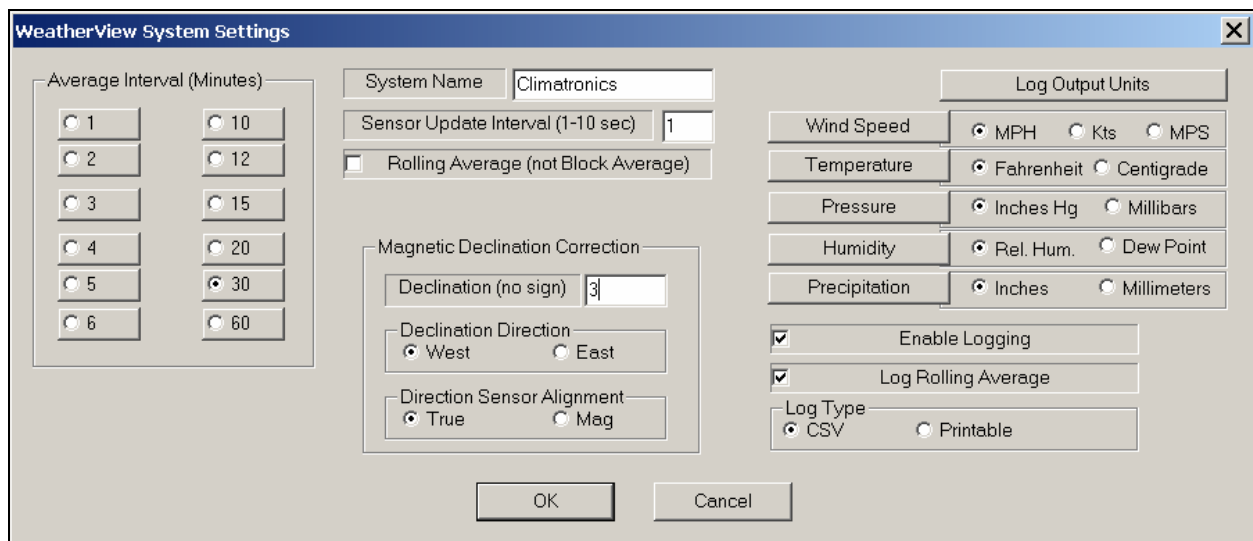

**Figure 1.5-7 Setup Menu**

#### 1.5.3.1 System Settings ...

Toolbar: No

Presents the WeatherView System Settings dialog box (shown in Figure 1.5-8) that allows the user to set several key system parameters.



**Figure 1.5-8 System Settings Dialog**

The user is able to specify a system name, which is shown on the airport and normal views (including the FTP'ed views) using the System Name entry box. The Sensor Update Interval must be set to the sensor update rate as defined by the specific hardware present for the given application. Failure to match the sensor update interval with the actual sensor update rate could lead to unpredictable and likely incorrect results. The Average Interval radio boxes enable the user to specify the time between the averaging and data output cycles (in minutes). Two types of data averaging are available: rolling average or block average. If a rolling average is selected, the main data display will be updated every sensor update interval and the average data shown represents the average of the values over the last average interval (as specified with the Average Interval radio boxes). If block average is selected on the other hand, the display will only update at the average interval selected and the average data shown represents the average over the prior average interval.

Writing of the data log can be enabled or disabled via the Enable Logging checkbox. Additionally, the user can specify if the log should contain the block or rolling average via the Log Rolling Average checkbox and can specify whether the log data file should be written with a space delimited printable format or a comma delimited, spreadsheet friendly 'CSV' format (see Section 1.3.2.2). The user can further specify the units associated with each of the sensors in the log output file using the appropriate log output units radio boxes. Note that the log output file units specification is entirely independent of the output units displayed on either the airport or normal displays.

The Magnetic Declination factors are used specify declination correction of the wind directions provided by the weather sensors. The Direction Sensor Alignment radio box is used to specify what the sensor is actually providing, either degrees True or degrees Magnetic. The Declination Direction specifies whether the declination is in degrees West or degrees East. Finally, if the Direction Sensor Alignment is specified as True, and the Declination Direction is East, or the Direction Sensor Alignment is specified as Magnetic, and the Declination Direction is West then the Declination specified is subtracted from the raw wind direction value provided by the sensor. Similarly, if the Direction Sensor Alignment is specified as True, and the Declination Direction is West, or the Direction Sensor Alignment is specified as Magnetic, and the Declination Direction is East then the Declination specified is added to the raw wind direction value provided by the sensor. Table 1.5-1 below summarizes what direction is displayed given the four combinations of sensor value and specified declination direction.

**Table 1.5-1 Displayed Direction versus Sensor Supplied Value and Direction**

	Declination Direction: WEST	Declination Direction: EAST
Sensor Supplies Values as: Degrees TRUE	Displayed Wind Direction = Sensor Value + Declination	Displayed Wind Direction = Sensor Value - Declination
Sensor Supplies Values as: Degrees MAGNETIC	Displayed Wind Direction = Sensor Value - Declination	Displayed Wind Direction = Sensor Value + Declination

Any changes to the system settings are recorded in the application ".ini" file when the application is exited allowing the last settings to be recalled when the application is started.

### 1.5.3.2 QNH/QFE Settings ...

Toolbar: No

Presents the QNH/QFE Settings dialog box (shown in Figure 1.5-9) that allows the user to set the heights used in the calculation of the QNH and QFE.

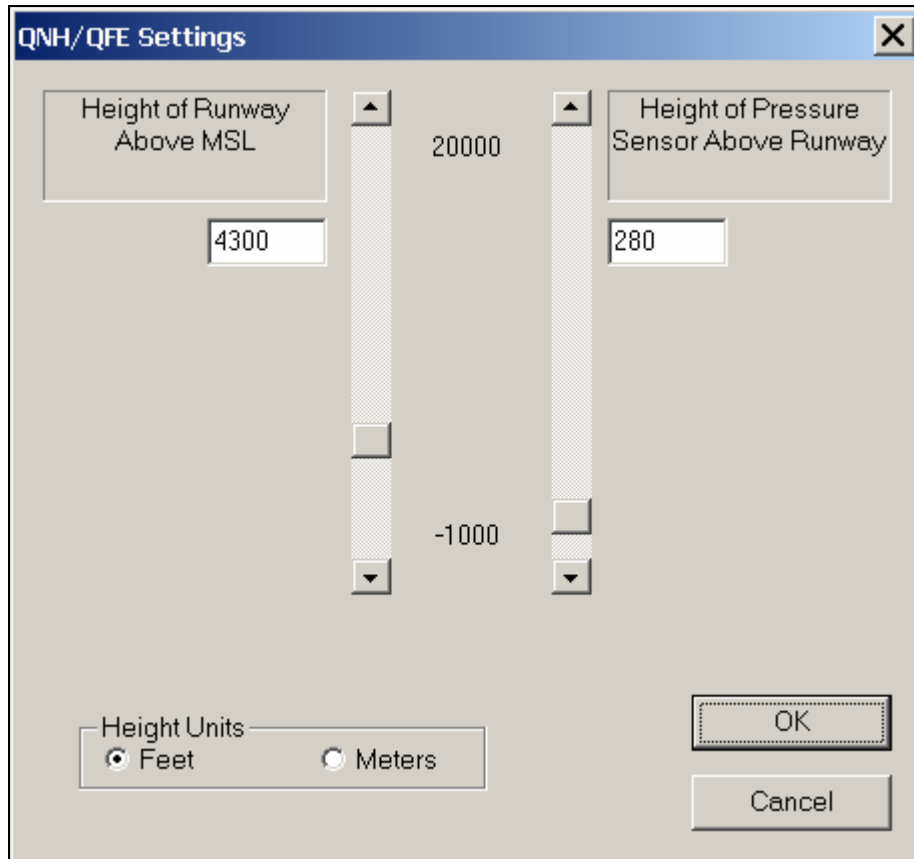

**Figure 1.5-9 QFE/QNH Settings Dialog**

The user is able to specify the Height of the Runway (above Mean Sea Level) by either typing the value in the entry field, clicking on the up or down arrows to increase or decrease the height or by clicking and dragging the vertical scroll bar to dynamically change the height. The Height of the Pressure Sensor above the runway can be set in a similar fashion by using the entry field, up and down buttons and vertical scroll bar dedicated to that value. Finally the units associated with both the Runway Height and Sensor Height can be selected using the Height Units radio buttons.

### 1.5.3.3 System Configuration

Toolbar: No

Presents the WeatherView System Configuration dialog box (sample shown in Figure 1.5-10) that allows the user to match the WeatherView application to the incoming sensor data stream.

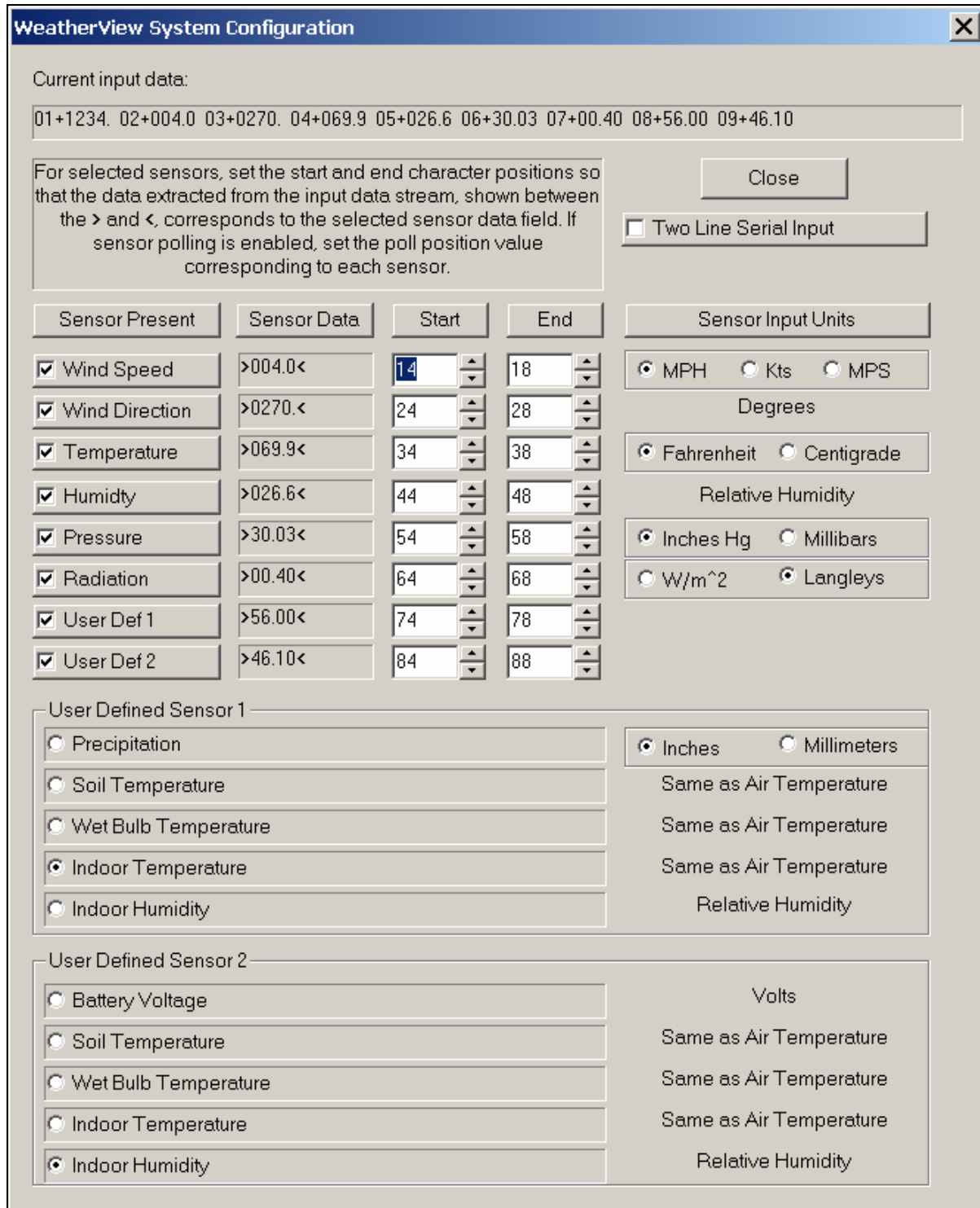

Figure 1.5-10 System Configuration Dialog

The format of the sensor data is dependent on the particular user's application. The top window of the System Configuration menu shows the current input data pattern. The user uses the rest of the dialog to match each meteorological sensor to the correct field in the data stream.

The check boxes next to each sensor enable the user to specify if a particular sensor is present in the application or not. For each sensor present, the user then uses the Start and End spin boxes to select the starting and ending characters in the data stream which correspond to the sensor data. The Sensor Data boxes update in real time to indicate the actual characters that will be used to specify the sensor data. The user can use the up and down arrows next to each spin box to vary the start and end points, or type directly into the start and end boxes. For certain sensor types, the user must specify the units associated with the input data. Note that this unit specification is independent of the output units displayed on either the airport or normal displays. The units specified on the System Configuration Menu must match the units associated with the input data, while the units chosen for the output displays are entirely up to the user.

Two user defined sensors selections are provided. The user can chose to have the second-to-last data field in the input data be associated with a precipitation, soil temperature, wet bulb temperature, indoor temperature or indoor humidity sensor, and the last data field to be associated to a battery voltage, soil temperature, wet bulb temperature, indoor temperature or indoor humidity sensor. Note that the sensor input units for the soil, wet bulb or indoor temperature sensors are always the same as the units set for the air temperature sensor and that the indoor humidity sensor input units always match the standard humidity sensor. Depending on the user defined selections, the lower-middle and lower-right digital display areas on the Normal Display will be modified to reflect the user defined data types. An example of the Normal display with the indoor temperature and humidity user defined sensors selected is shown in Figure 1.5-11

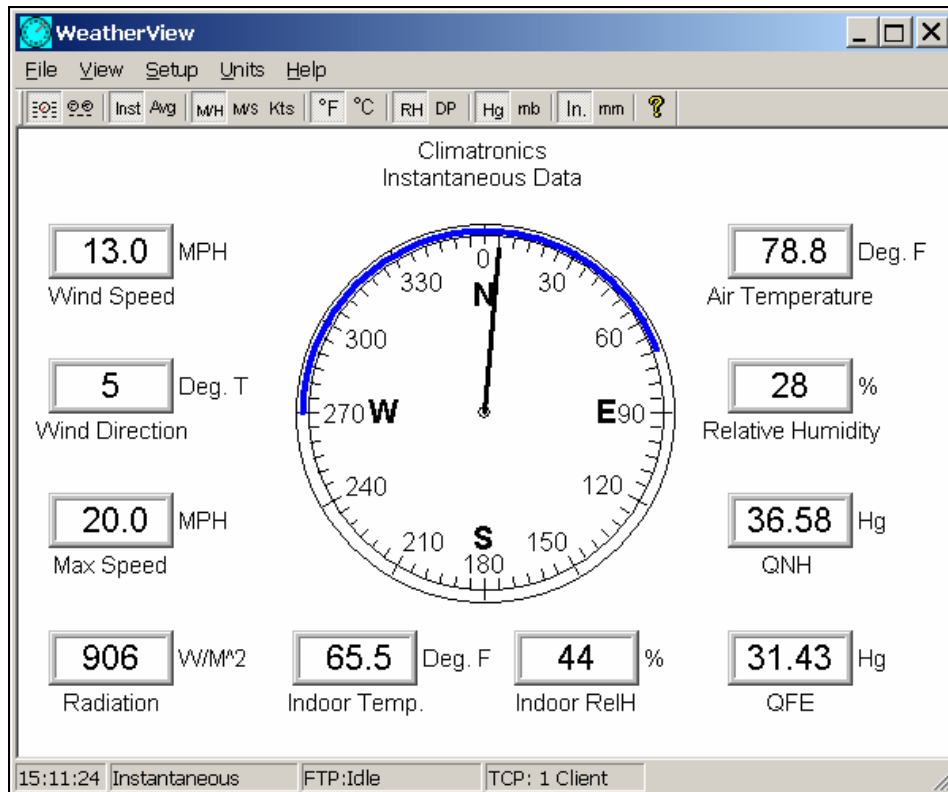

Figure 1.5-11 Indoor Temperature/Humidity User Defined Sensors Example

The “Two Line Serial Input” checkbox is used to indicate that the serial input stream is formatted in two lines. That is, the input stream for one complete message consists of 80 characters of data, a carriage return-line feed pair, additional data characters, and a final carriage return-line feed pair.

Changes to the system configuration are recorded in the application “.ini” file when the application is exited allowing the last settings to be recalled and used when the application is started.

### 1.5.3.4 Serial Interface Settings

Toolbar: No

Presents the Sensor Serial Interface Settings dialog box (shown in Figure 1.5-12) that allows the user to specify the serial interface parameters.

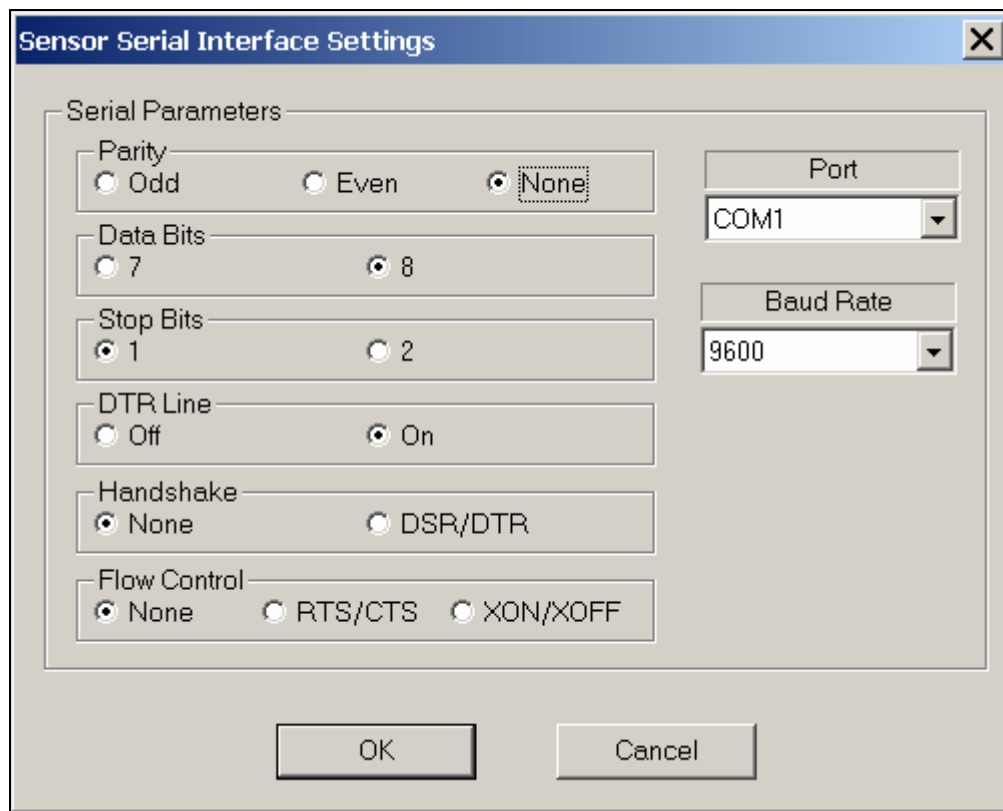

**Figure 1.5-12 Sensor Serial Interface Settings Dialog**

The Port pulldown, Baud rate pulldown and Parity, Data Bits and Stop Bits radio boxes are used to match the WeatherView serial port settings to the incoming sensor data stream parameters. Similarly the DTR Line, Handshake and Flow Control radio boxes are used for specialized applications which require specific DTR state, hardware handshaking or software flow control consideration.

Changes to the serial interface settings are recorded in the application “.ini” file when the application is exited allowing the last settings to be recalled when the application is started.

### 1.5.3.5 FTP Settings

Toolbar: No

Presents the FTP Settings dialog box (shown in Figure 1.5-13) that allows the user to specify the FTP interface parameters.

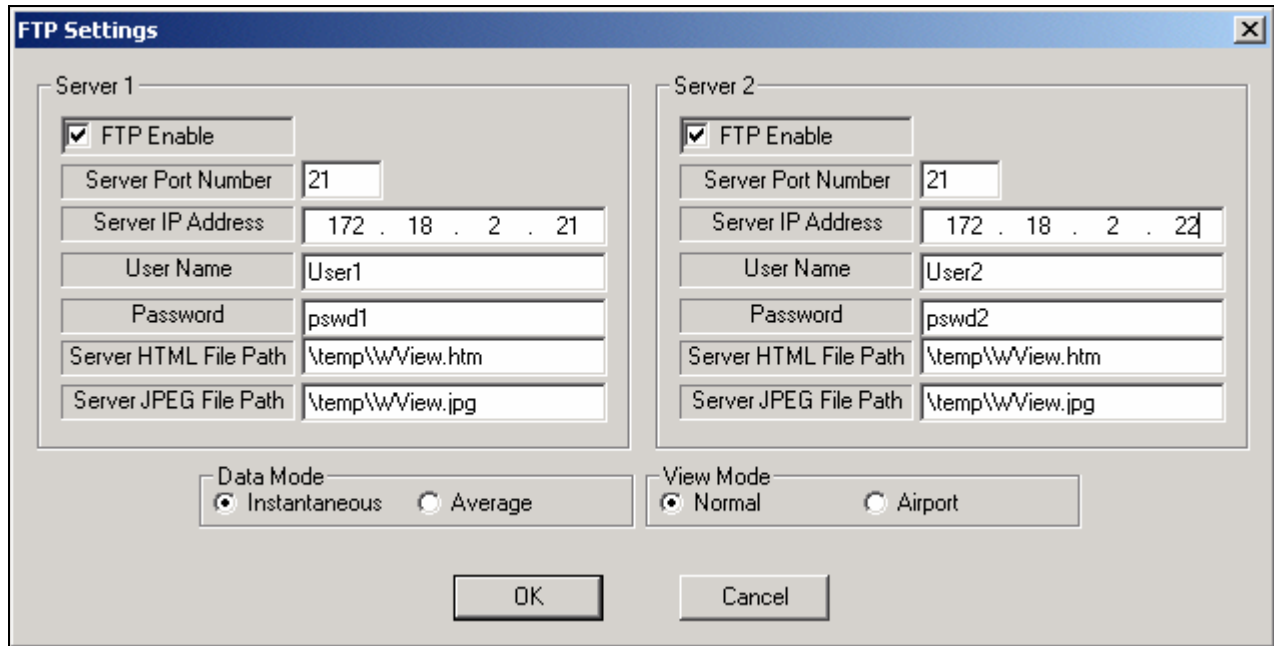

**Figure 1.5-13 FTP Settings Dialog**

For each of the two servers, the FTP Enable check boxes specify whether or not the FTP upload capability should be enabled for that server. If enabled, the user must fill in the Server Port Number, Server IP Address, User Name and Password boxes to specify the IP address and port of the FTP server and the user login information. The FTP server's system administrator should be able to supply these parameters. The HTML and JPEG File Path dialog boxes are used to specify which directory the two FTP files should be written to on the FTP server. The JPEG file is a raw copy of the specified view, while the HTML file is the file opened by the web browser to display the JPEG file.

The user can use the Data Mode and View Mode radio boxes to select which variation of the four views should be uploaded to the FTP server. If the user selects the 'Instantaneous' data mode, the data will be uploaded every five seconds. If the user specifies the 'Average data mode, the data will be uploaded at the end of the data averaging period. Note that the Data Mode and View Mode settings apply to both servers.

Changes to the FTP setup are recorded in the application ".ini" file when the application is exited allowing the last settings to be recalled when the application is started.

### 1.5.3.6 TCP/IP Settings ...

Toolbar: No

Presents the TCP/IP Settings dialog box (shown in Figure 1.5-14) that allows the user to specify the port of the WeatherView server (base station).

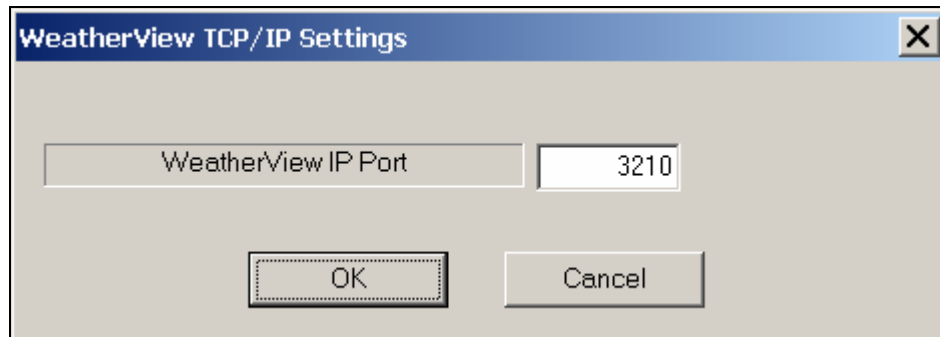
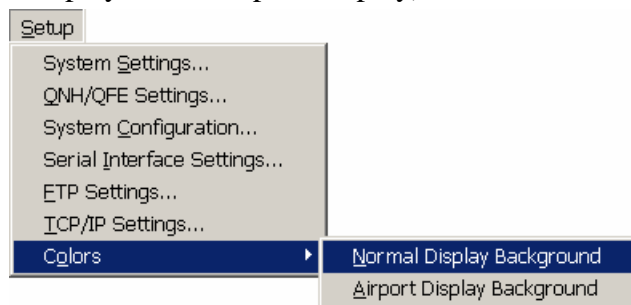

**Figure 1.5-14 TCP/IP Settings Dialog**

### 1.5.3.7 Colors

Toolbar: No

Presents a sub menu (shown in Figure 1.5-15) that allows the user to select which background color (either the Normal Display or the Airport Display) is to be modified.



**Figure 1.5-15 Background Selection Submenu**

The standard Windows Color menu (shown in Figure 1.5-16) is then displayed to allow the use to select the background color.

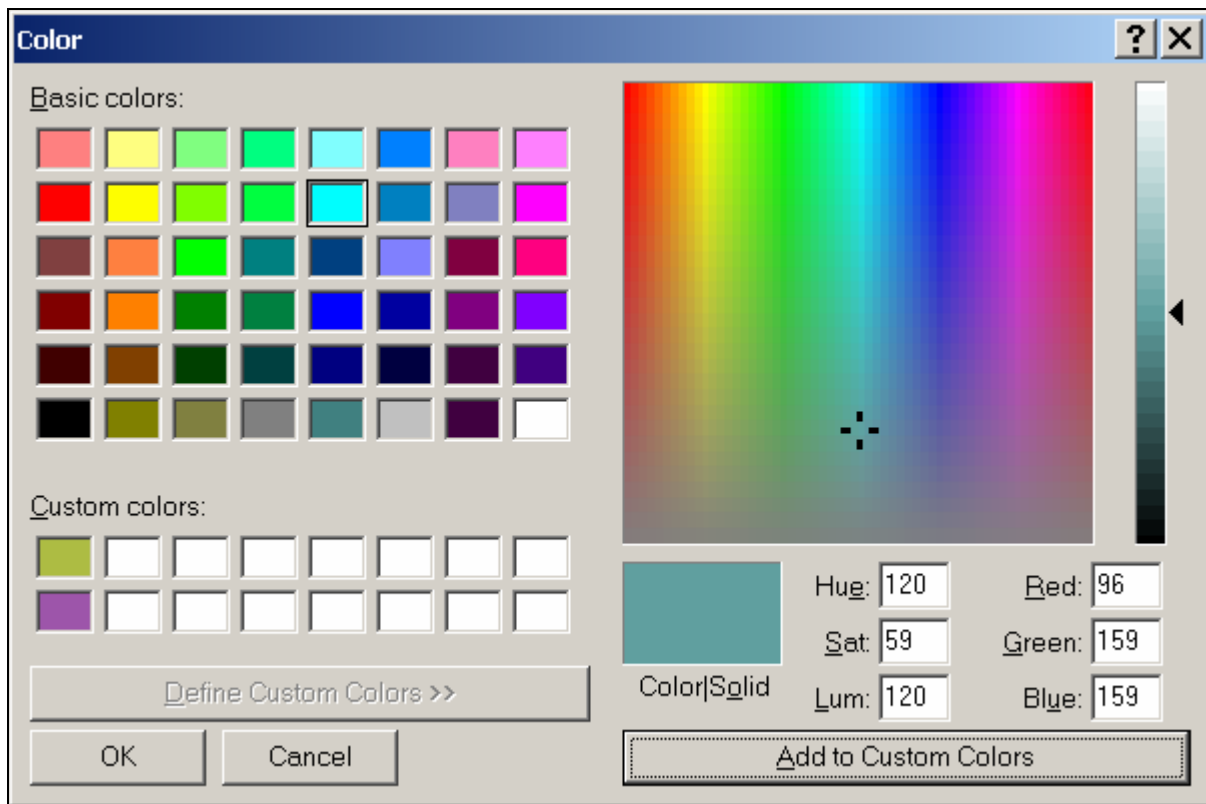

**Figure 1.5-16 Color Selection Menu**

The user can click on any of the Basic Colors presented, or specify a custom color using the extensive color creation capabilities. Any change to the background color is recorded in the application “.ini” file when the application is exited allowing the last settings to be recalled when the application is started.

**1.5.4 Units**

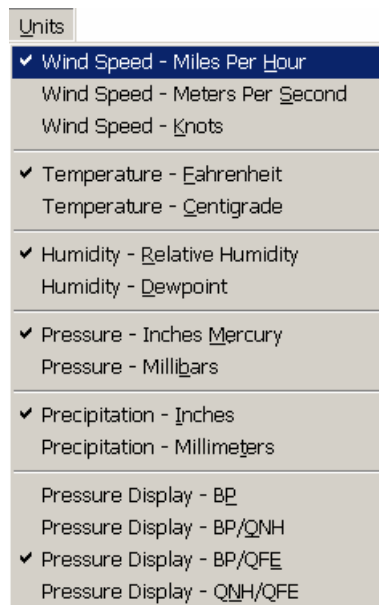

**Figure 1.5-17 Units Menu**

The Units Menu allows the user to modify the displayed units of measure for all weather data (log output units are specified separately via the System Settings dialog) as well as the preferred type of pressure display (barometric pressure, barometric pressure and QNH, barometric pressure and QFE or QNH and QFE). A check mark next to a unit indicates the current selected display units for that sensor type. The current units selection is saved in the application “.ini” file when the application is exited allowing the last settings to be recalled when the application is started.

#### **1.5.4.1 Wind Speed – Miles Per Hour**

Toolbar: 

Sets the units of measure for all wind speed indications to miles per hour.

#### **1.5.4.2 Wind Speed – Meters Per Second**

Toolbar: 

Sets the units of measure for all wind speed indications to meters per second.

#### **1.5.4.3 Wind Speed – Knots**

Toolbar: 

Sets the units of measure for all wind speed indications to knots.

#### **1.5.4.4 Temperature – Fahrenheit**

Toolbar: 

Sets the units of measure for the air temperature indication (and dew point, soil, wet bulb or indoor temperatures as applicable) to degrees Fahrenheit.

#### **1.5.4.5 Temperature – Centigrade**

Toolbar: 

Sets the units of measure for the air temperature indication (and dew point, soil, wet bulb or indoor temperatures as applicable) to degrees centigrade.

#### **1.5.4.6 Humidity – Relative Humidity**

Toolbar: 

Sets the humidity indication to show relative humidity in percent.

#### **1.5.4.7 Humidity – Dewpoint**

Toolbar: 

Sets the humidity indication to show the dewpoint in degrees Fahrenheit or centigrade depending on the temperature units selected.

**1.5.4.8 Pressure – Inches Mercury**Toolbar: 

Sets the units of measure for all pressure indications (BP, QNH, QFE) to inches of mercury.

**1.5.4.9 Pressure – Millibars**Toolbar: 

Sets the units of measure for all pressure indications (BP, QNH, QFE) to millibars.

**1.5.4.10 Precipitation – Inches**Toolbar: 

Sets the units of measure for the precipitation indication to inches.

**1.5.4.11 Precipitation – Millimeters**Toolbar: 

Sets the units of measure for the precipitation indication to millimeters.

**1.5.4.12 Pressure Display – BP**

Toolbar: None

Specifies that both the airport and normal views should display only the barometric pressure.

**1.5.4.13 Pressure Display – BP/QNH**

Toolbar: None

Specifies that both the airport and normal views should display the barometric pressure and QNH.

**1.5.4.14 Pressure Display – BP/QFE**

Toolbar: None

Specifies that both the airport and normal views should display the barometric pressure and QFE.

**1.5.4.15 Pressure Display – QNH/QFE**

Toolbar: None

Specifies that both the airport and normal views should display the QNH and QFE.

## 1.5.5 Help



**Figure 1.5-18 Help Menu**

### 1.5.5.1 WeatherView Help...

Toolbar: 

Provides access to the WeatherView help database via an installed web browser.

### 1.5.5.2 About WeatherView ...

Toolbar: No

Displays a dialog box (shown in Figure 1.5-19) containing information about the WeatherView application such as the current version number.

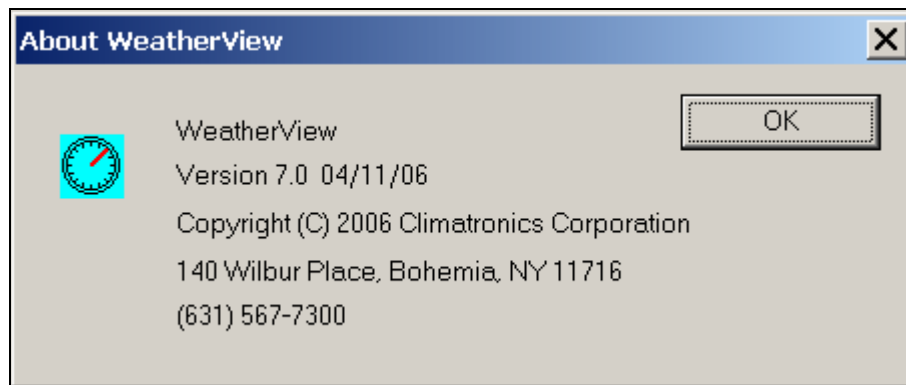

**Figure 1.5-19 About WeatherView Dialog**

## 1.6 Remote Workstation - Application View

The main application views while configured as a remote workstation (the instantaneous airport remote view is shown for example in Figure 1.6-1) are nearly identical to those when configured in base station mode, however remote mode capabilities are somewhat limited.

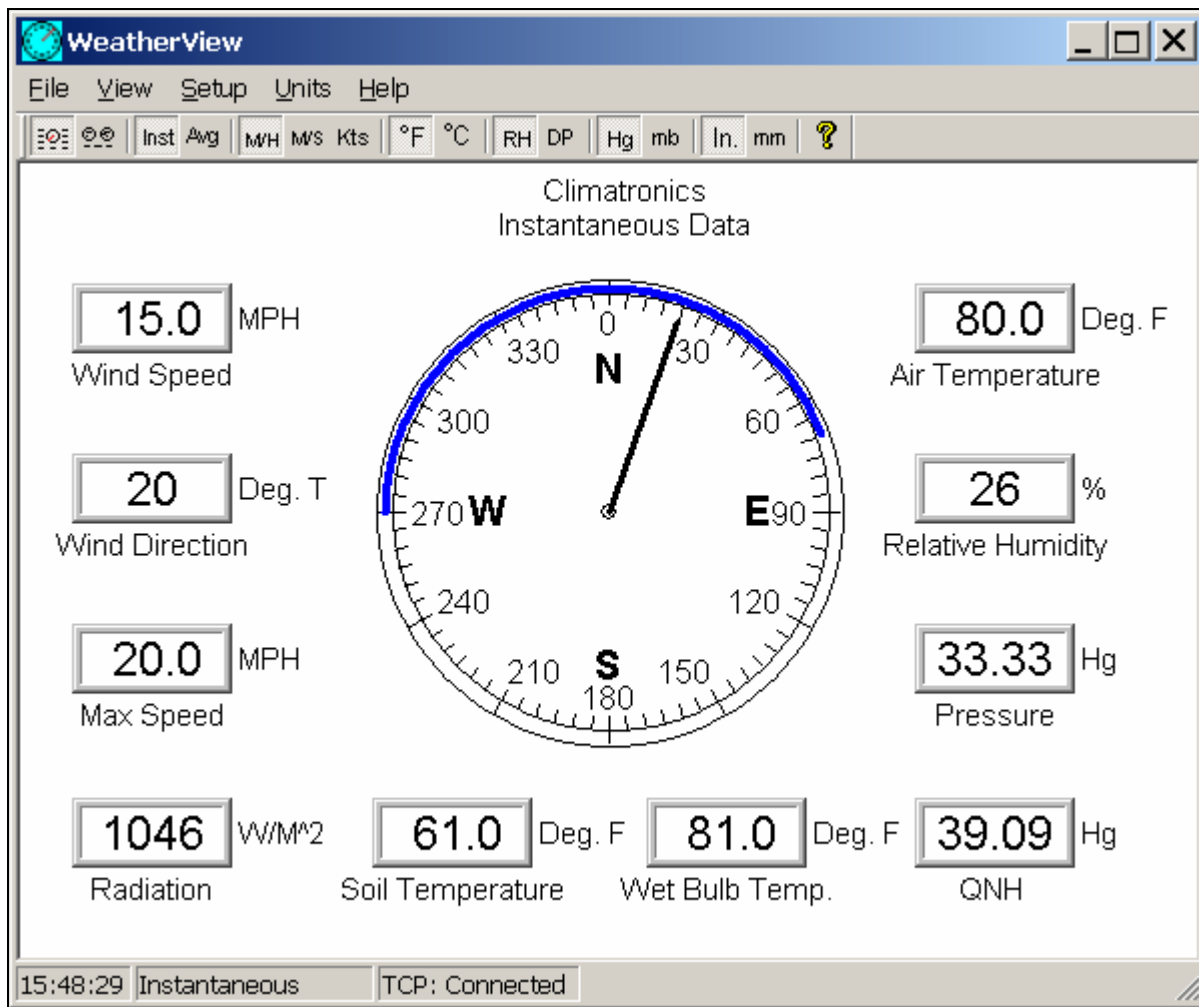

**Figure 1.6-1 Remote Workstation Application View**

When configured as a remote workstation, the user is prevented from viewing log data or configuring the log data units (data logging is only done at the base workstation), viewing the sensor input data stream, setting up the basic system settings or sensor configuration or setting up the FTP transfer settings (FTP upload is only done by the base workstation).

Additionally, the status bar at the bottom of the view shows only the system time, type of data currently displayed (either instantaneous or average) and the TCP/IP connection status (see Section 1.2). Otherwise, the form and function of the remote application views are identical to the base station view.

## 1.7 Remote Workstation - Application Menus

Operation of the WeatherView application in remote mode is a limited version of the operations available in base station mode. The following sections describe the functions performed by each menu and submenu item while in WeatherView remote mode.

### 1.7.1 Remote Workstation - File



Figure 1.7-1 Remote Workstation - File Menu

#### 1.7.1.1 Remote Workstation - Exit

Toolbar: No

Exits the application.

### 1.7.2 Remote Workstation - View

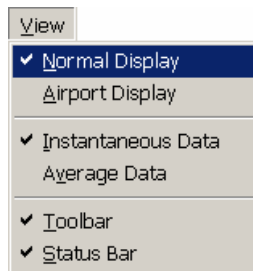

Figure 1.7-2 Remote Workstation - View Menu

#### 1.7.2.1 Remote Workstation - Normal Display

Toolbar: 

The normal display view is opened. Refer to Section 1.4.1 for a complete description of this view.

#### 1.7.2.2 Remote Workstation - Airport Display

Toolbar: 

The airport display view is opened. Refer to section 1.4.2 for a complete description of this view.

#### 1.7.2.3 Remote Workstation - Instantaneous Data

Toolbar: 

The current data view (either airport or normal) is modified to show the instantaneous data values being received from the base station.

#### 1.7.2.4 Remote Workstation - Average Data

Toolbar: 

The current data view (either airport or normal) is modified to show the average data values over the specified average interval.

### 1.7.2.5 Remote Workstation - Toolbar

Toolbar: No

The display of the main application toolbar is toggled on or off.

### 1.7.2.6 Remote Workstation - Status Bar

Toolbar: No

The display of the main application status bar is toggled on or off.

## 1.7.3 Remote Workstation - Setup

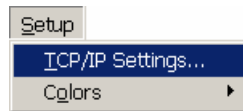

Figure 1.7-3 Remote Workstation - Setup Menu

### 1.7.3.1 Remote Workstation - TCP/IP Settings ...

Toolbar: No

Presents the TCP/IP Settings dialog box (shown in Figure 1.7-4) that allows the user to specify the IP Address and port of the WeatherView server (base station).

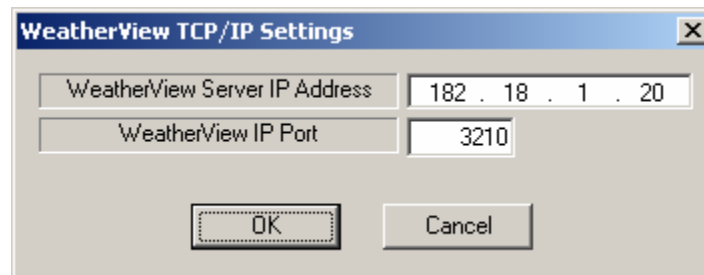

Figure 1.7-4 Remote Workstation - TCP/IP Settings Dialog

### 1.7.3.2 Remote Workstation - Colors

Toolbar: No

Presents a sub menu (shown in Figure 1.7-5) that allows the user to select which background color (either the Normal Display or the Airport Display) is to be modified.



Figure 1.7-5 Remote Workstation - Background Selection Submenu

The standard Windows Color menu (shown in Figure 1.7-6) is then displayed to allow the use to select the background color.

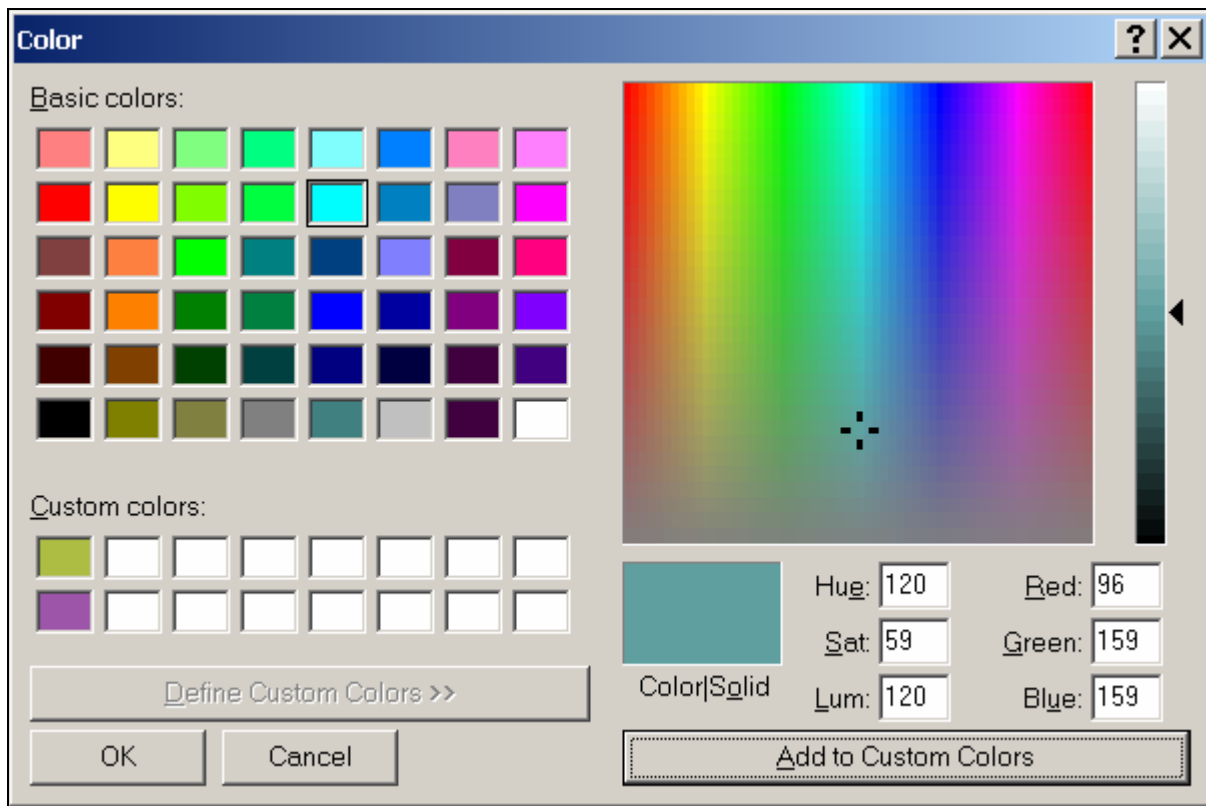

**Figure 1.7-6 Remote Workstation - Color Selection Menu**

The user can click on any of the Basic Colors presented, or specify a custom color using the extensive color creation capabilities. Any change to the background color is recorded in the application “.ini” file when the application is exited allowing the last settings to be recalled when the application is started.

**1.7.4 Units**

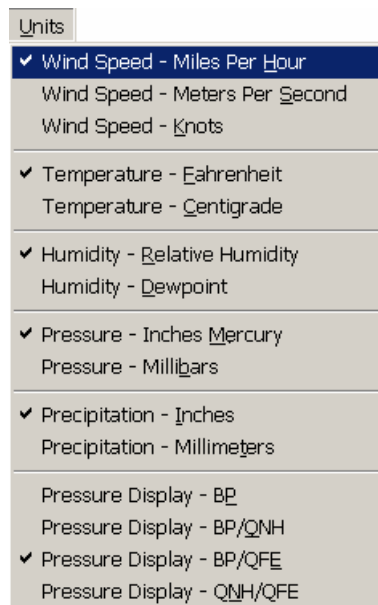

**Figure 1.7-7 Remote Workstation - Units Menu**

---

The Units Menu allows the user to modify the displayed units of measure for all weather data as well as the preferred type of pressure display (barometric pressure, barometric pressure and QNH, barometric pressure and QFE or QNH and QFE). A check mark next to a unit indicates the current selected display units for that sensor type. The current units selection is saved in the application “.ini” file when the application is exited allowing the last settings to be recalled when the application is started.

#### **1.7.4.1 Remote Workstation - Wind Speed – Miles Per Hour**

Toolbar: 

Sets the units of measure for all wind speed indications to miles per hour.

#### **1.7.4.2 Remote Workstation - Wind Speed – Meters Per Second**

Toolbar: 

Sets the units of measure for all wind speed indications to meters per second.

#### **1.7.4.3 Remote Workstation - Wind Speed – Knots**

Toolbar: 

Sets the units of measure for all wind speed indications to knots.

#### **1.7.4.4 Remote Workstation - Temperature – Fahrenheit**

Toolbar: 

Sets the units of measure for the air temperature indication (and dew point, soil, wet bulb or indoor temperatures as applicable) to degrees Fahrenheit.

#### **1.7.4.5 Remote Workstation - Temperature – Centigrade**

Toolbar: 

Sets the units of measure for the air temperature indication (and dew point, soil, wet bulb or indoor temperatures as applicable) to degrees centigrade.

#### **1.7.4.6 Remote Workstation - Humidity – Relative Humidity**

Toolbar: 

Sets the humidity indication to show relative humidity in percent.

#### **1.7.4.7 Remote Workstation - Humidity – Dewpoint**

Toolbar: 

Sets the humidity indication to show the dewpoint in degrees Fahrenheit or centigrade depending on the temperature units selected.

#### **1.7.4.8 Remote Workstation - Pressure – Inches Mercury**

Toolbar: 

Sets the units of measure for the pressure indication to inches of mercury.

**1.7.4.9 Remote Workstation - Pressure – Millibars**Toolbar: 

Sets the units of measure for all pressure indications (BP, QNH, QFE) to millibars.

**1.7.4.10 Remote Workstation - Precipitation – Inches**Toolbar: 

Sets the units of measure for all pressure indications (BP, QNH, QFE) to inches.

**1.7.4.11 Remote Workstation - Precipitation – Millimeters**Toolbar: 

Sets the units of measure for the precipitation indication to millimeters.

**1.7.4.12 Remote Workstation - Pressure Display – BP**

Toolbar: None

Specifies that both the airport and normal views should display only the barometric pressure.

**1.7.4.13 Remote Workstation - Pressure Display – BP/QNH**

Toolbar: None

Specifies that both the airport and normal views should display the barometric pressure and QNH.

**1.7.4.14 Remote Workstation - Pressure Display – BP/QFE**

Toolbar: None

Specifies that both the airport and normal views should display the barometric pressure and QFE.

**1.7.4.15 Remote Workstation - Pressure Display – QNH/QFE**

Toolbar: None

Specifies that both the airport and normal views should display the QNH and QFE.

## 1.7.5 Remote Workstation - Help



**Figure 1.7-8 Remote Workstation - Help Menu**

### 1.7.5.1 Remote Workstation - WeatherView Help...

Toolbar: 

Provides access to the WeatherView help database via an installed web browser.

### 1.7.5.2 Remote Workstation - About WeatherView ...

Toolbar: No

Displays a dialog box (shown in Figure 1.7-9) containing information about the WeatherView remote application such as the current version number.

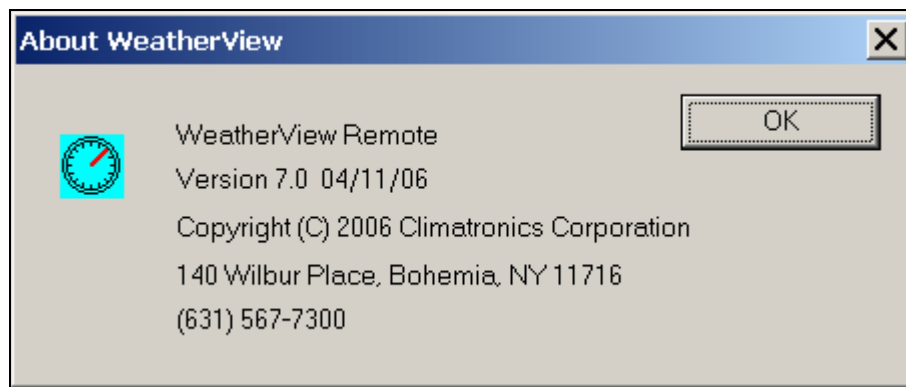

**Figure 1.7-9 Remote Workstation - About WeatherView Remote Dialog**